

MECHANICAL POST TABLE - MT-2442-HP

APPROX WEIGHT: 328.12 lbs.
 DOES NOT INCLUDE WEIGHT OF POWER OR PACKAGING!!!

ANY ADDITIONS, DELETIONS, OR OMISSIONS MUST BE CORRECTED ON THIS DRAWING AS THIS DRAWING WILL BE CONSIDERED ALL INCLUSIVE

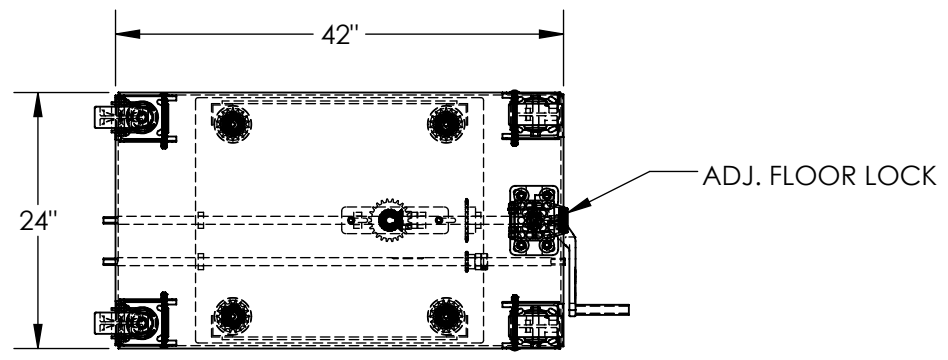
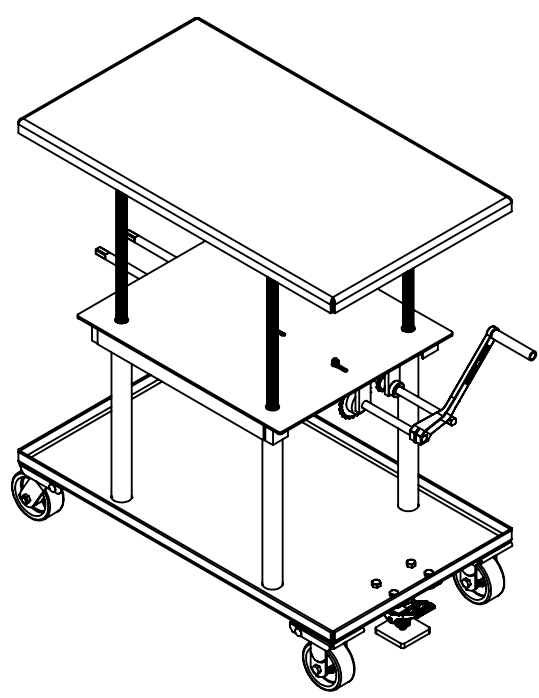
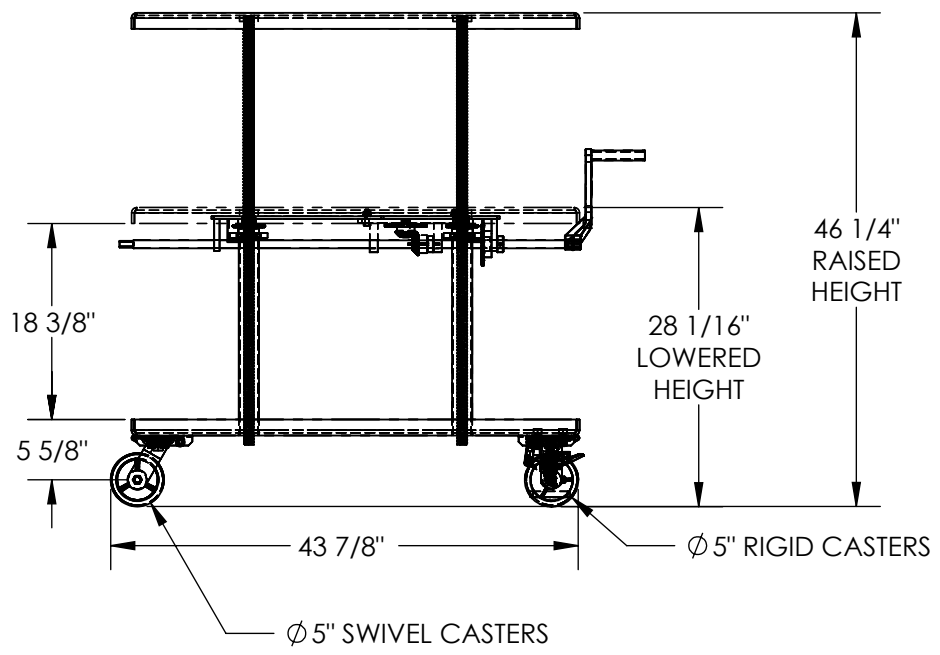

ALL GRAPHICS PROVIDED ARE FOR REFERENCE ONLY. IF CERTAIN DIMENSIONS ARE CRITICAL PLEASE VERIFY THOSE DIMENSIONS WITH YOUR SALESPERSON

DIMENSION TOLERANCE ± 1/4"

STANDARD FEATURES

- MODEL NUMBER IS MT-2442-HP
- CAPACITY: 2,000 LBS.
- PLATFORM WIDTH : 24"
- PLATFORM LENGTH: 42"
- RAISED HEIGHT: 46 1/4"
- LOWERED HEIGHT: 28 1/16"
- HIGH-PROFILE OPERATION
- PRECISION SPROCKET/GEAR LIFTING MECH.
- LOW SPEED IS 1/8" PER CRANK
- HIGH SPEED IS 5/16" PER CRANK
- (2) - 5 X 2 POLY ON STEEL SWIVEL CASTERS
- (2) - 5 X 2 POLY ON STEEL RIGID CASTERS
- INCLUDES FLOOR LOCK
- DURABLE LIQUID PAINT BLUE FINISH

SPECIAL FEATURES

NONE

A P P R O V A L	I, THE UNDERSIGNED, AGREE THAT THE PRODUCT AS REPRESENTED SATISFIES DESIGN AND DIMENSION REQUIREMENTS. I ALSO ACKNOWLEDGE MY DUTY TO CONFIRM PRODUCT AND INSTALLATION COMPLIANCE WITH ALL APPLICABLE FEDERAL, STATE AND LOCAL REGULATIONS AND STANDARDS.	
	UNITS REQUIRING APPROVAL DRAWINGS OR MODIFIED ARE NON-RETURNABLE	
	[] As drawn [] As marked	
	Signed: _____ Date: _____	
Printed Name: _____		
LEAD TIME WILL START UPON RECEIPT OF SIGNED APPROVAL DRAWING		

DISTRIBUTOR'S NAME:		P.O.#
VESTIL MANUFACTURING		X
		W.O.#
DRAWN BY: DEY		X
DATE: 02/29/12		SALES: X
REFERENCE: X	SCALE: 1:18	FILE NAME:
QUOTED LEAD TIME: X	QUOTE # X	21-007-026